

VARCO DRILLERS' CONSOLE

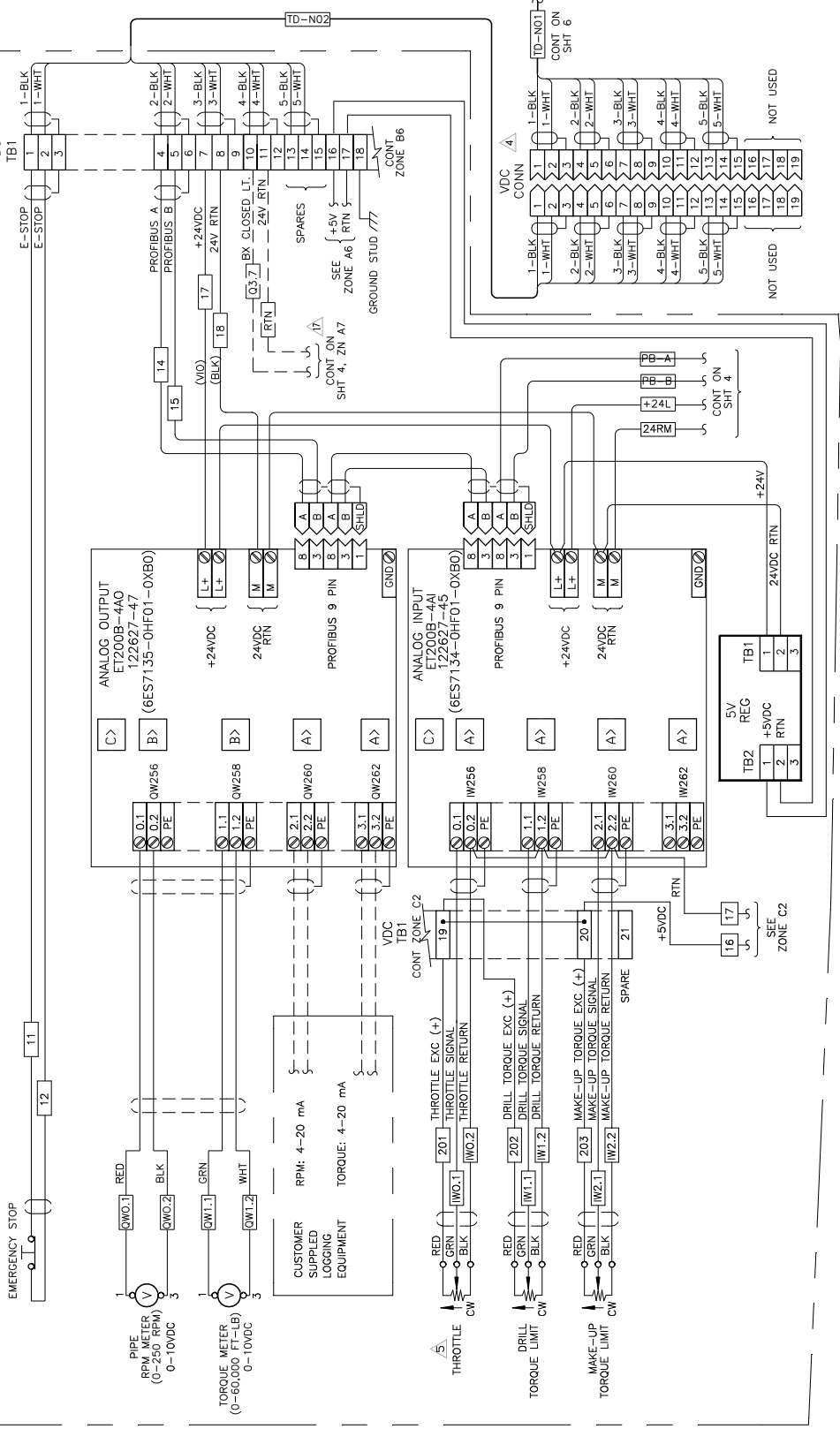

CONT ON SHT 4

VARCO DRILLERS' CONSOLE WITHOUT HEATER

SIZE	DWG NO	REV
D	124222	K
SCALE	1/1" = 1" LBS	- SHEET
		2 OF 13

REF002 REV. D1

VARCO DRILLERS' CONSOLE

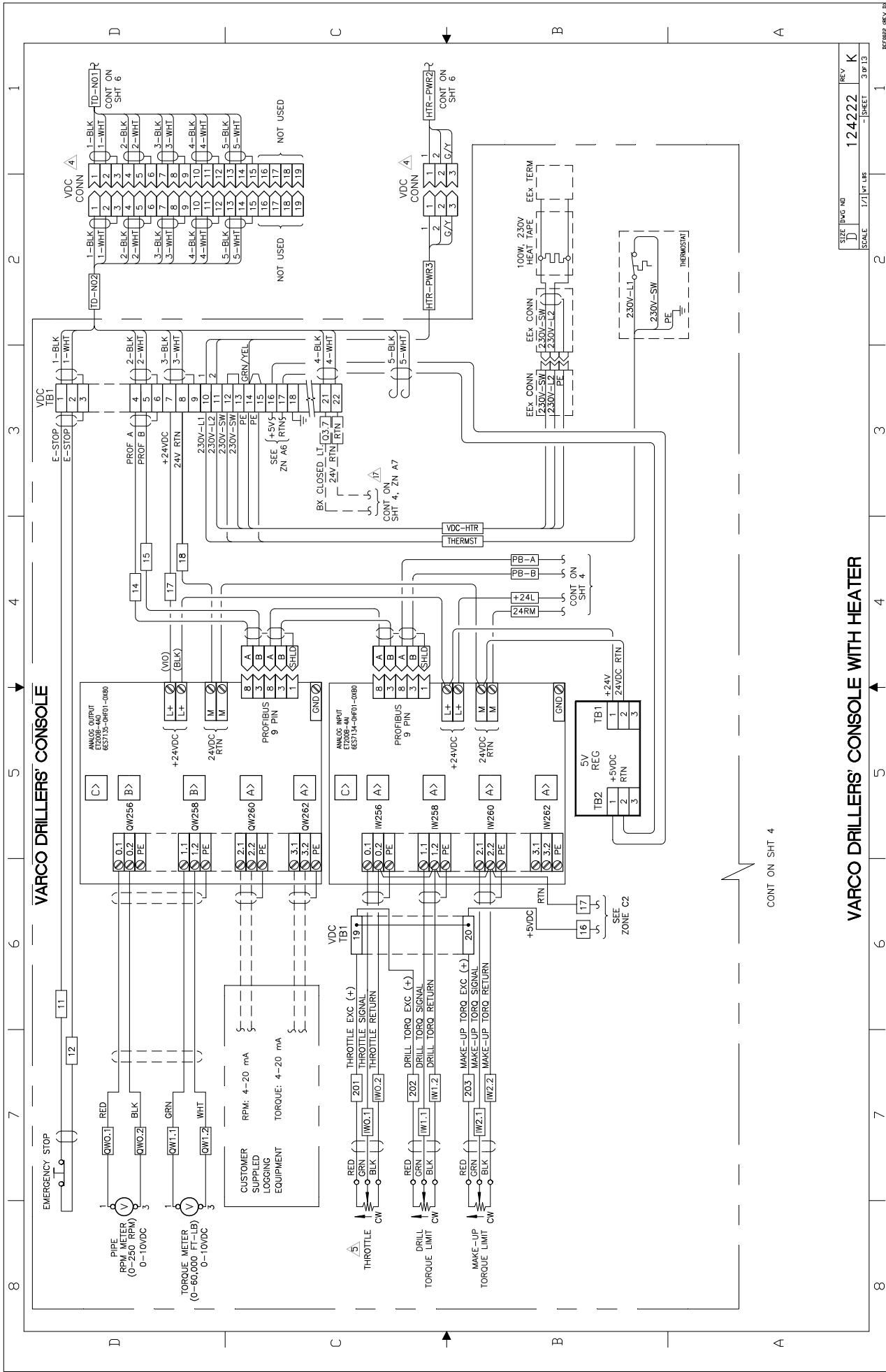

CONT ON SHT 4

VARCO DRILLERS' CONSOLE WITH HEATER

SIZE DWG NO	124222	REV	K
SCALE	1/1" = 1" LBS	SHEET	3 OF 13

8 7 6 5 4 3 2 1

VARCO DRILLERS' CONSOLE

CONT. FROM SHT 2 or 3

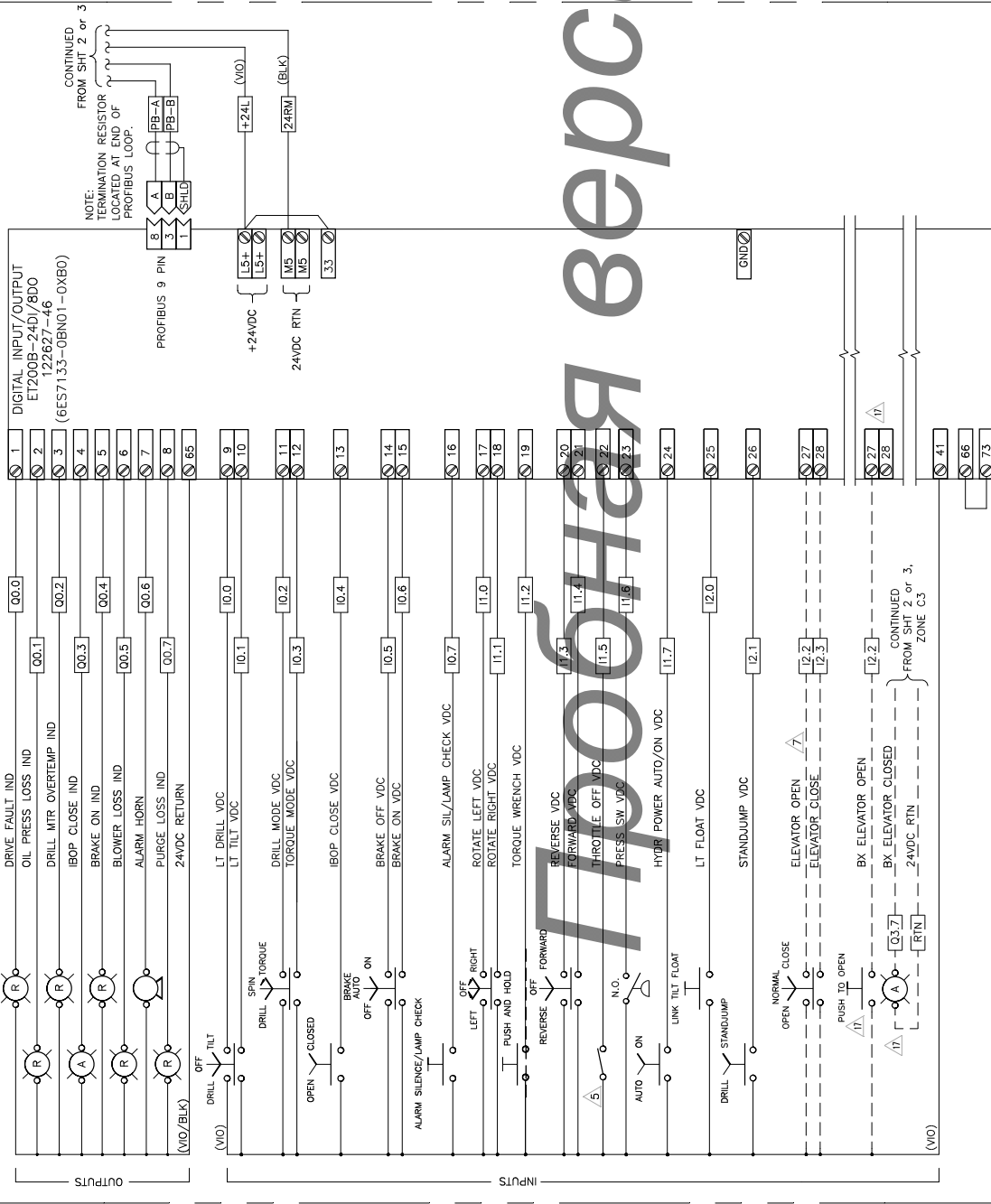

SIZE	DWG NO	REV
D	124222	K
SCALE	1/1	SHEET 4 OF 13

REV 02/02

PLC

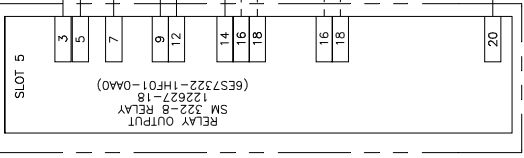
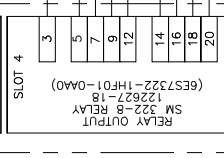
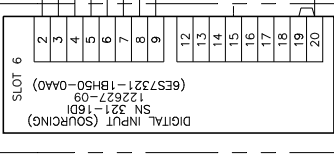

DRIVE HOUSE

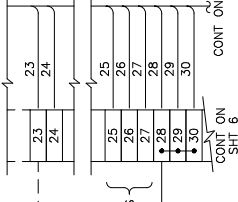
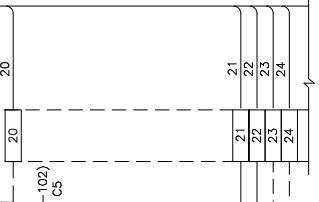
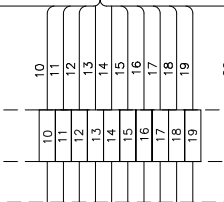
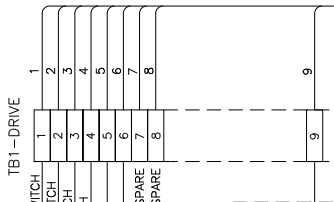

CONNECTOR

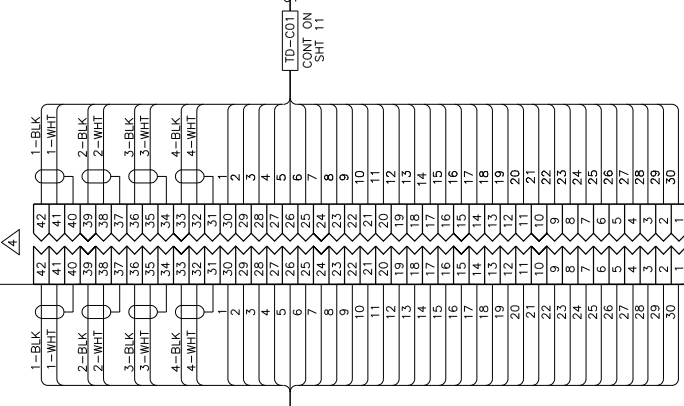

SIZE DWG NO 124222
SCALE 1/1"=1'-0"
REV K
SHEET 5 OF 13

CONT ON SHEET 6

CONT ON SHT. 6

REV K

124222

SCALE 1/1"=1'-0"

SHEET 5 OF 13

DRIVE HOUSE

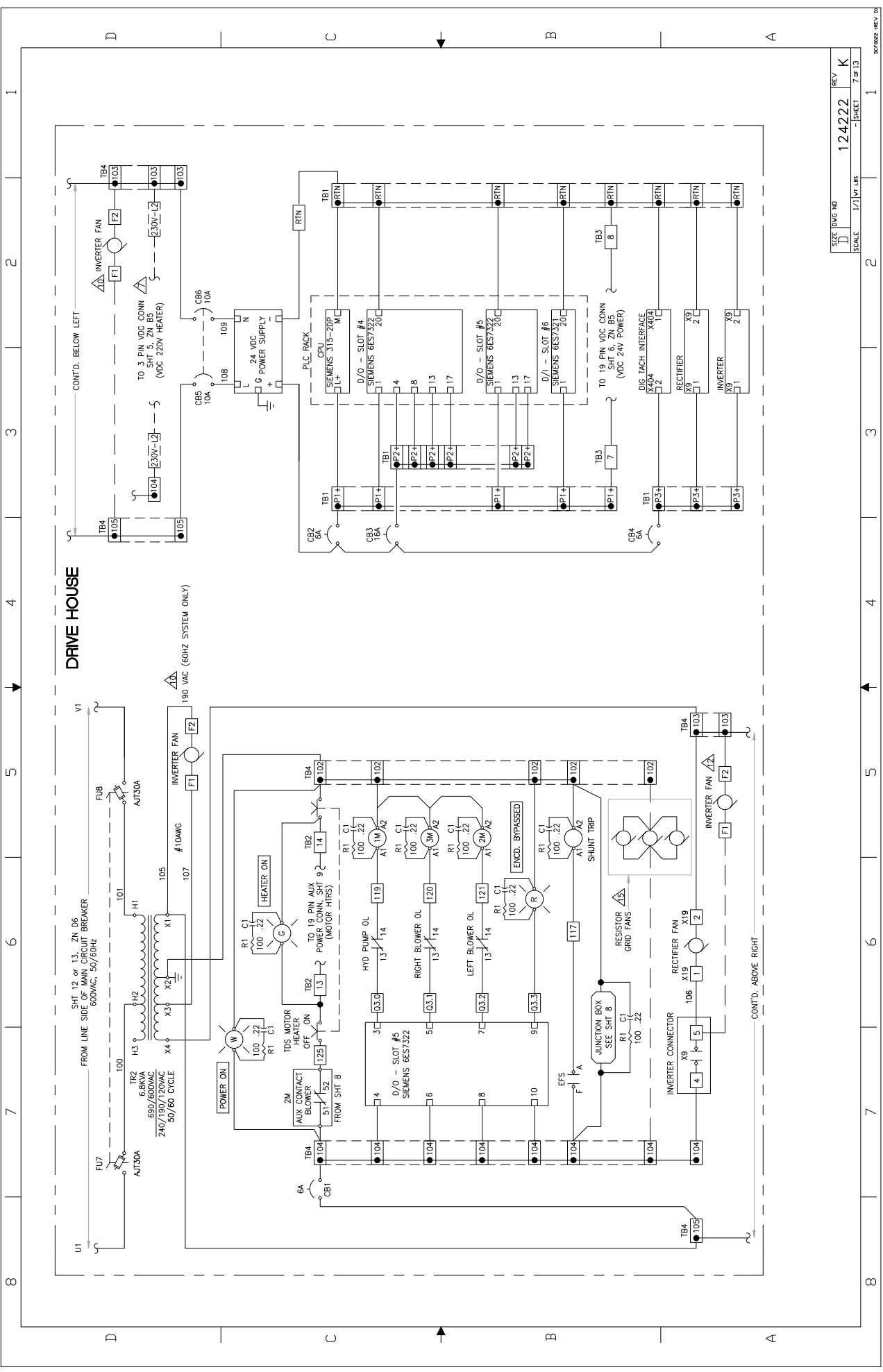

CONT'D. BELOW LEFT

CONT'D. ABOVE RIGHT

SIZE	DWG NO	REV
D	124222	K
SCALE	1/1" = 1' L.S.	7 OF 13

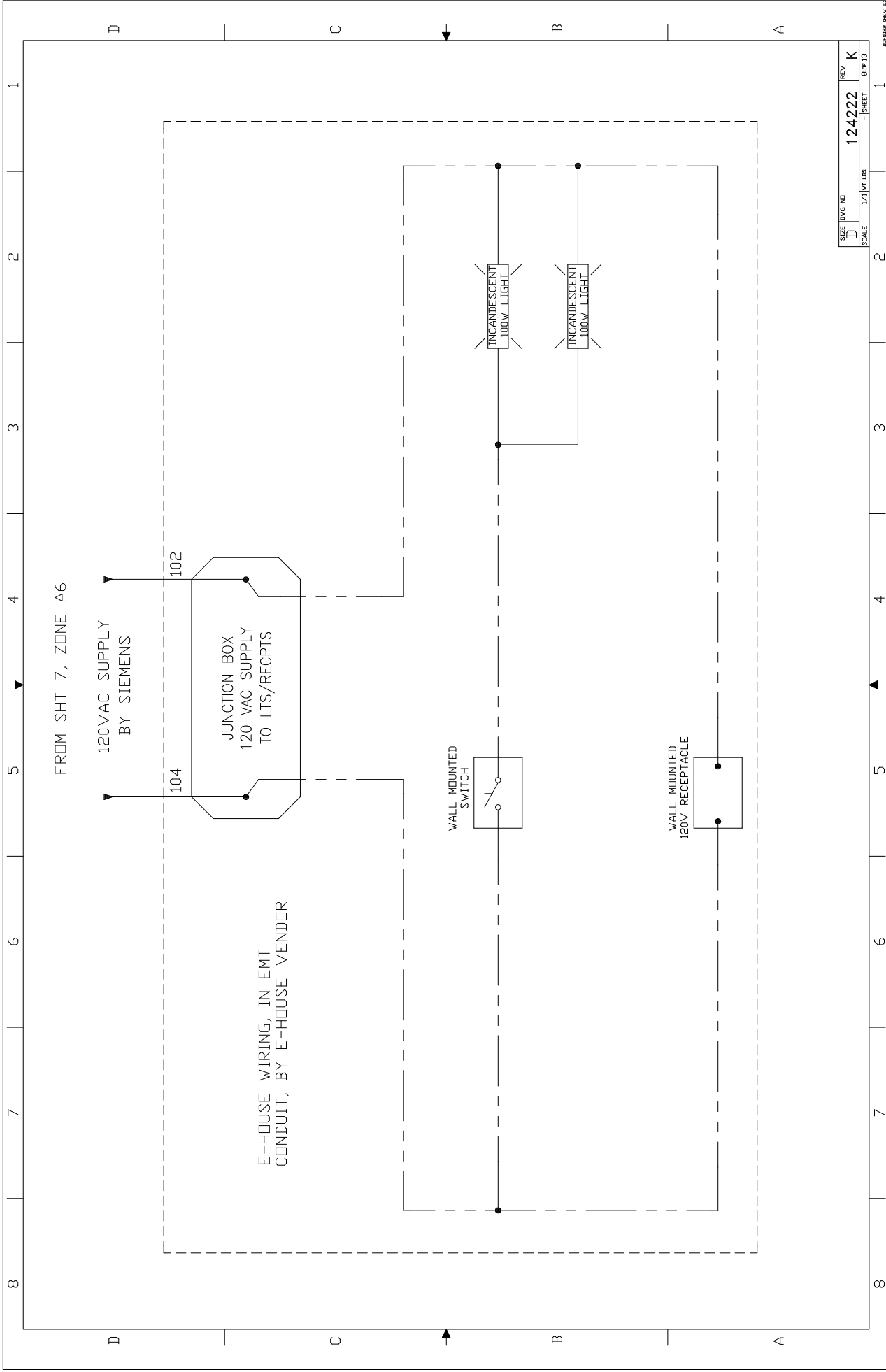

SIZE	DWG NO	REV
D	124222	K
SCALE	1/1" = 1' 0"	SHEET 8 OF 13

FROM SHT 7, ZONE A6
 120VAC SUPPLY BY SIEMENS
 JUNCTION BOX 120 VAC SUPPLY TO LTS/RECPTS
 E-HOUSE WIRING, IN EMT CONDUIT, BY E-HOUSE VENDOR
 WALL MOUNTED SWITCH
 WALL MOUNTED 120V RECEPTACLE
 INCANDESCENT 100W LIGHT
 INCANDESCENT 100W LIGHT
 104
 102
 A B C D
 1 2 3 4 5 6 7 8

DRIVE HOUSE

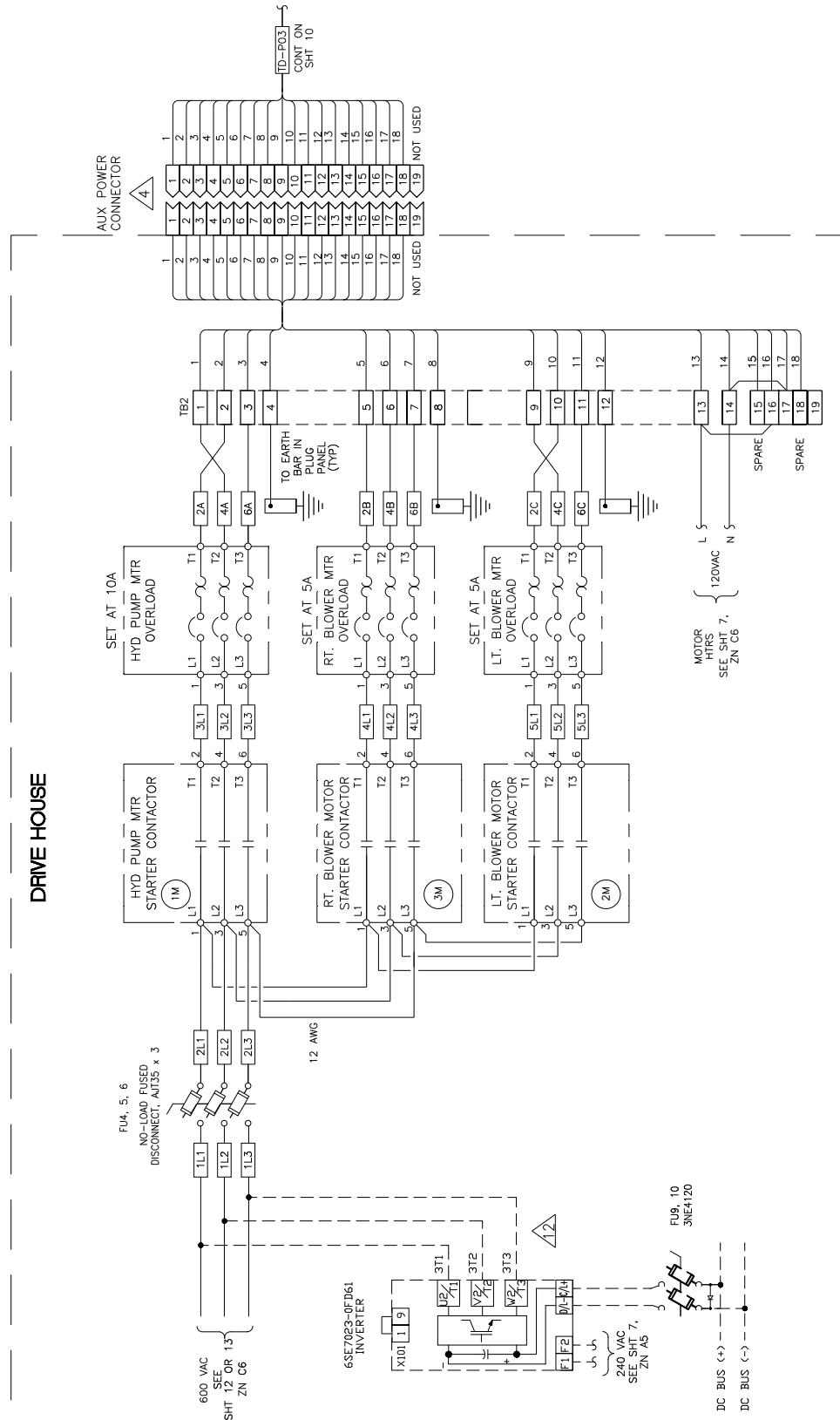

SIZE	DWG NO	REV	K
D	124222		
SCALE	1/1" = 1' LBS	- SHEET	9 OF 13

REF002 REV. 01

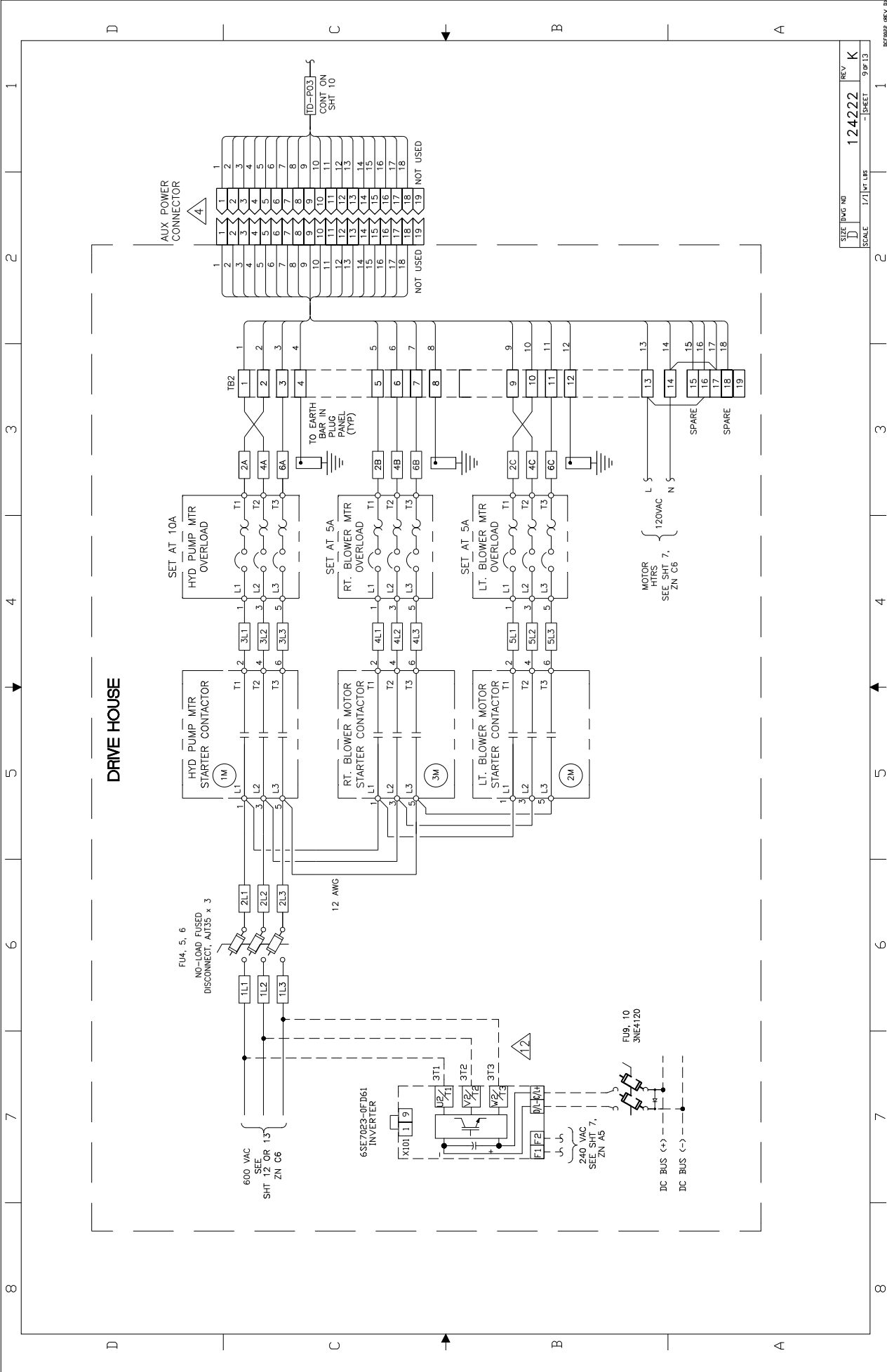

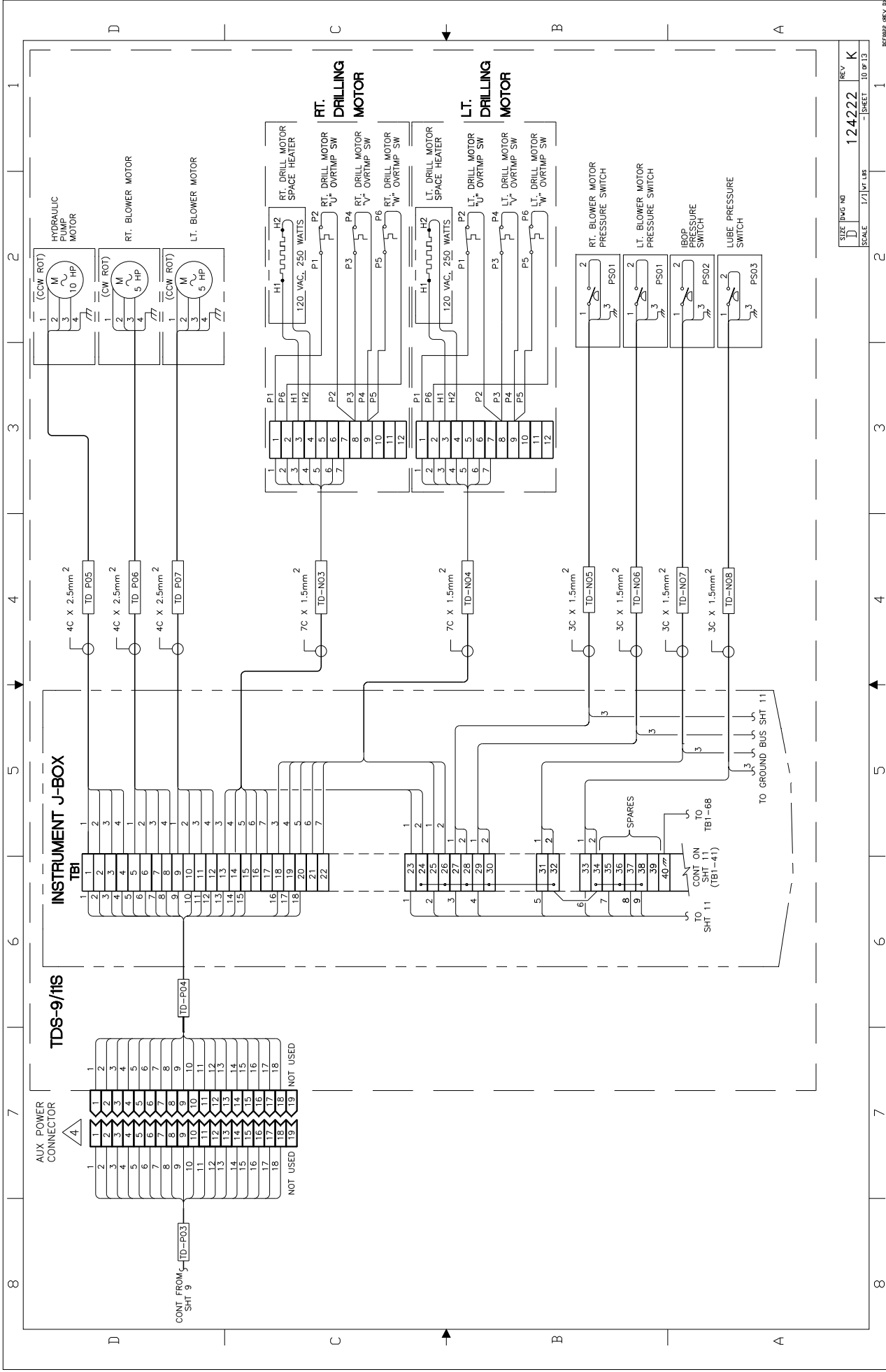

INSTRUMENT J-BOX

TDS-9/11S

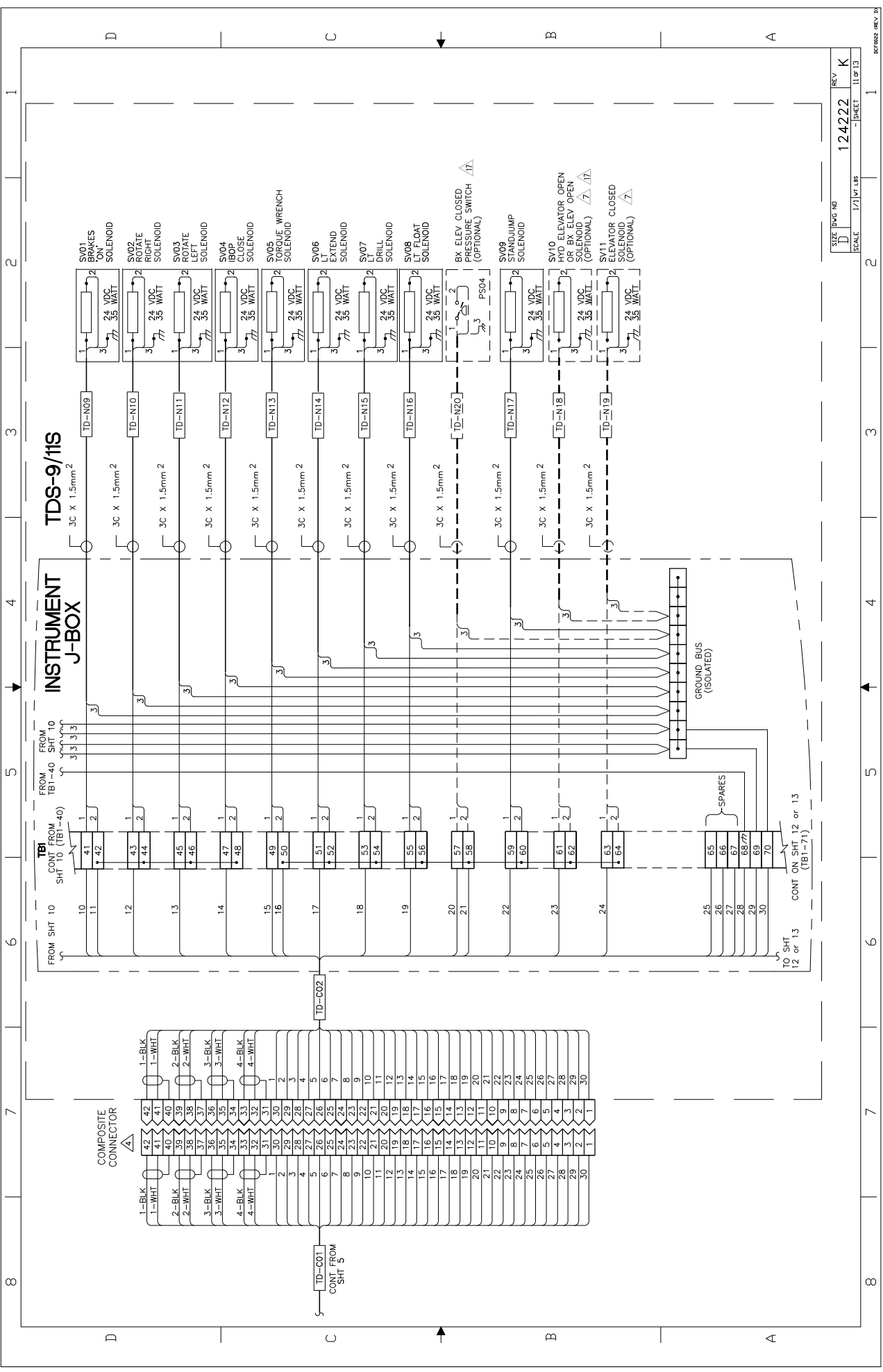

SIZE DWG NO **124222** REV **K**
 SCALE 1/1" = 1' - SHEET 11 OF 13

REF002 REV. 01

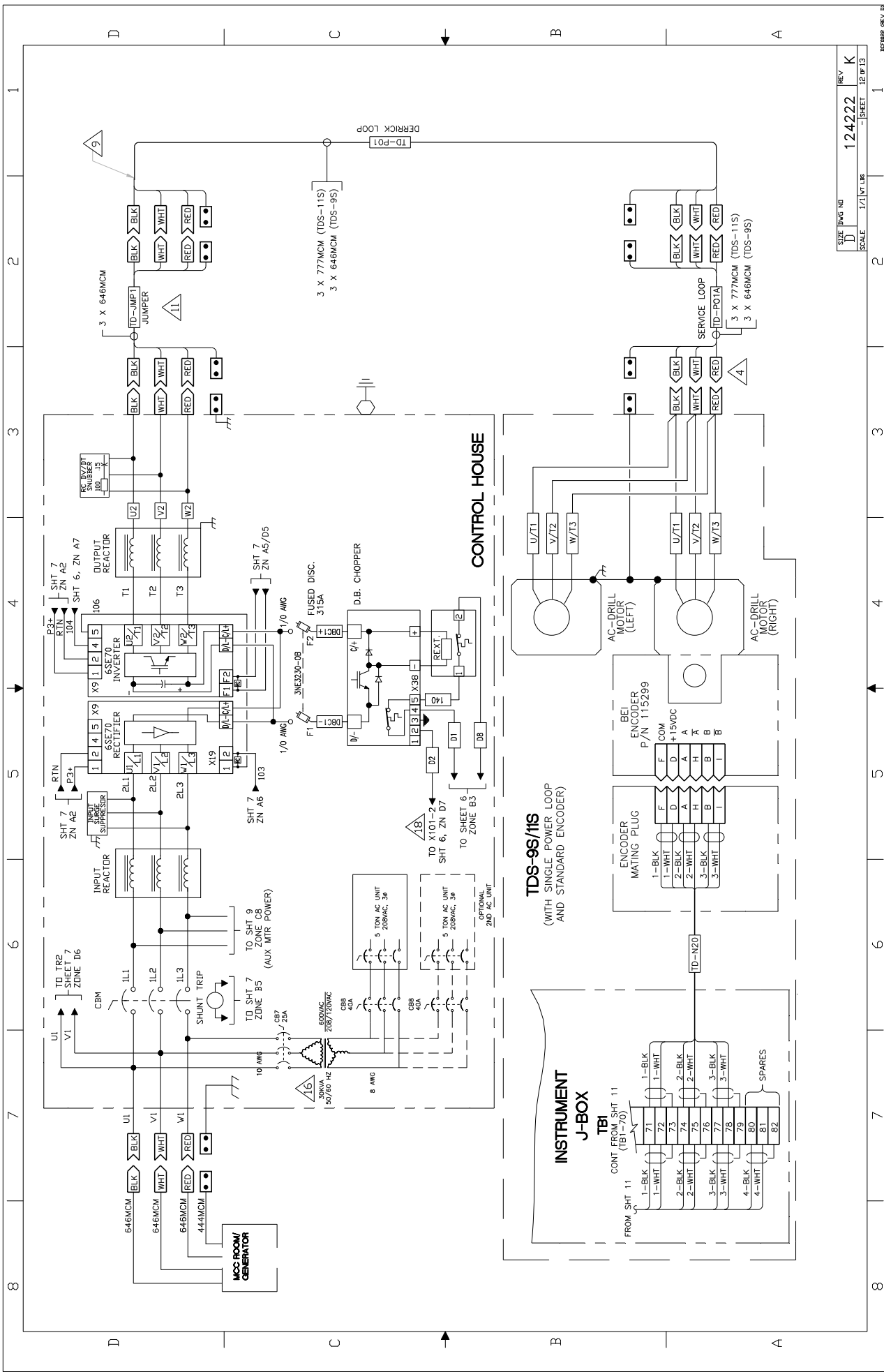

SIZE	DWG NO	REV
D	124222	K
SCALE	1/1 WT LBS	- SHEET 12 OF 13

124222 REV K
 12 OF 13 SHEETS
 1/1 WT LBS SCALE

